

# MONGIN

*le concept de coupe*

## CORRUGATED BOARD INDUSTRY

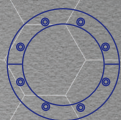

### 03

For decades, MONGIN have been following the evolution of high standards in the corrugated board industry. The expertise gained over the years is proof of our manufacturing "Savoir faire". Our customer loyalty demonstrates our quality and our large, modern production capability is evidence of our performance and adaptability.

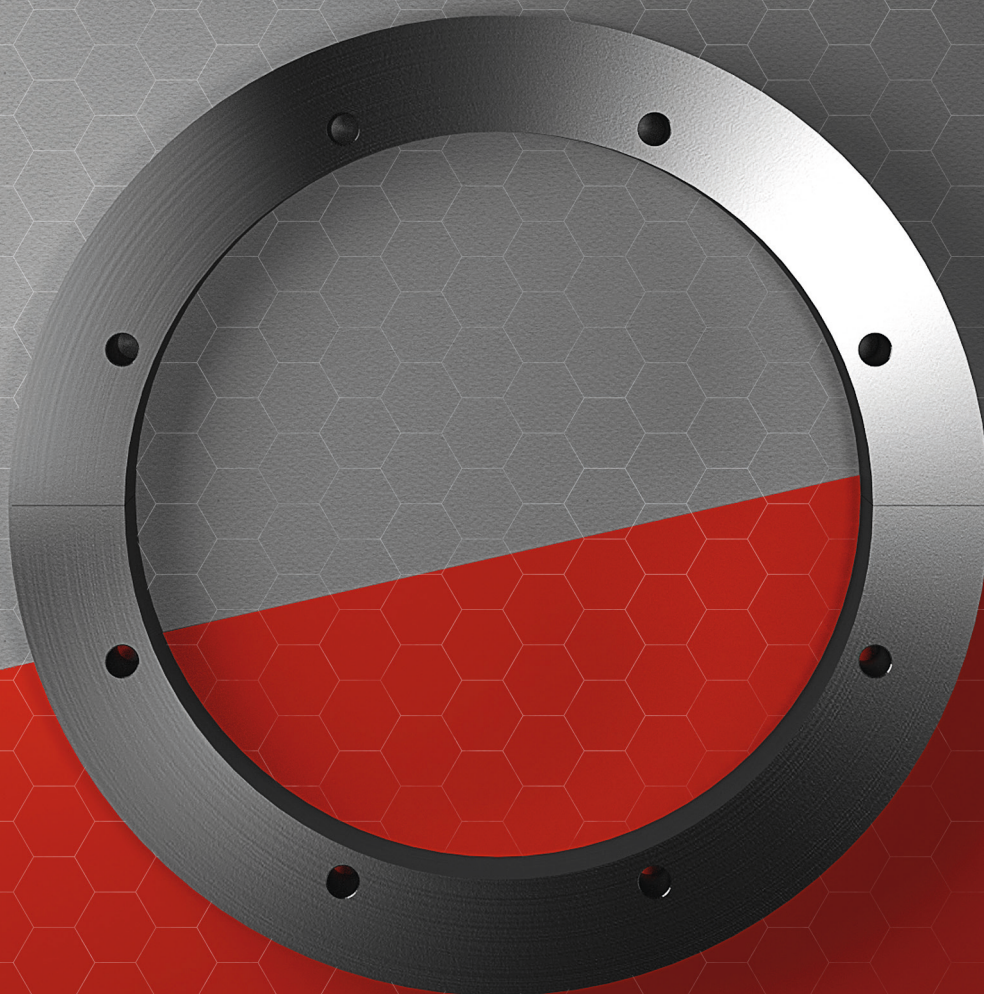

# CORRUGATOR LINE

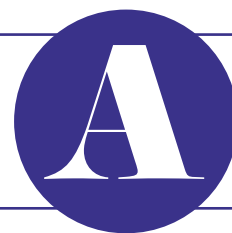

## SINGLE FACER

*Pieces are in bronze or brass*

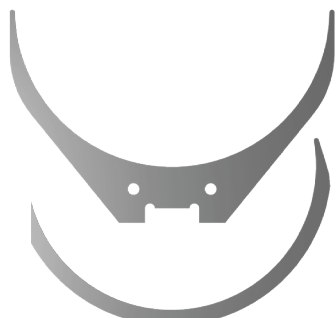

## SLITTER SCORER

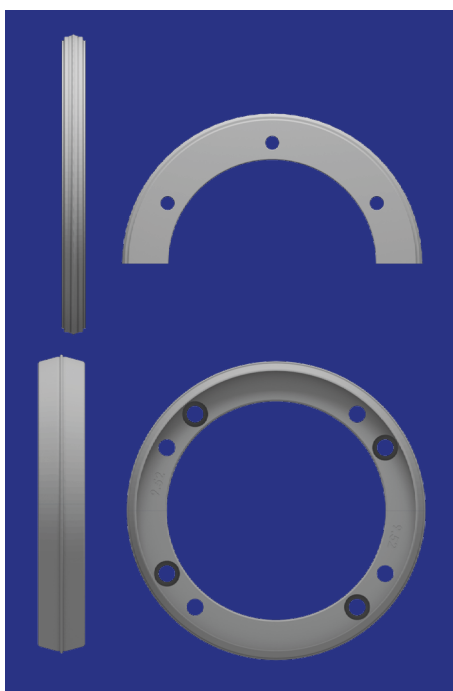

## CROSS CUTTER

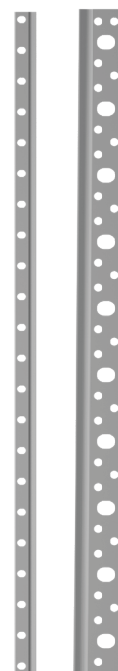

# SLOTTER



## SLOTTING

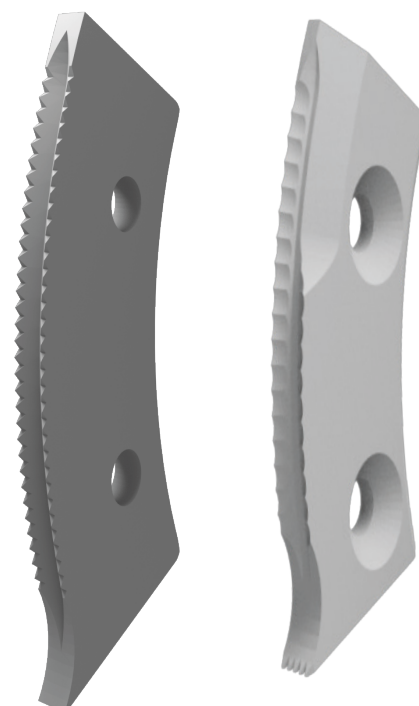
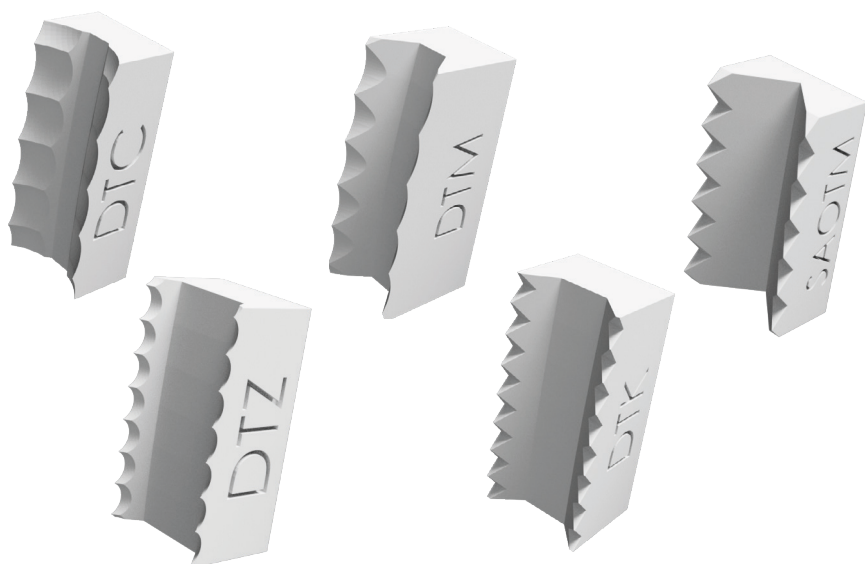

*Slotting knife - DTC / DTK / DTM / DTZ / SAOTM serration*

**STRIPPERS**

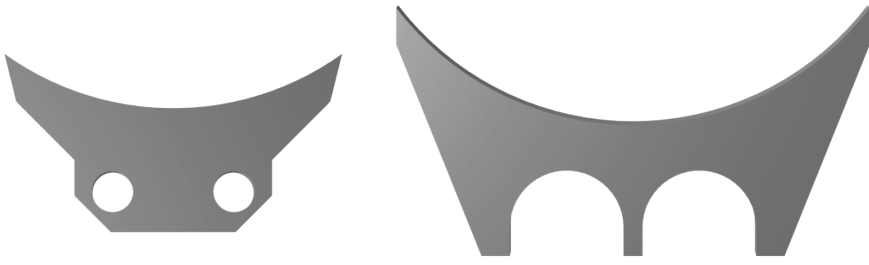

**TRIM EDGES**

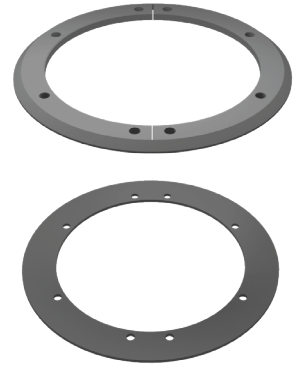

**WEARING DISC**

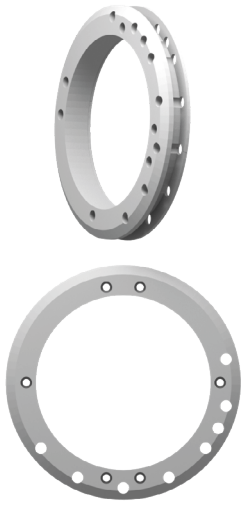

**LAP CUTTING BLOCK**

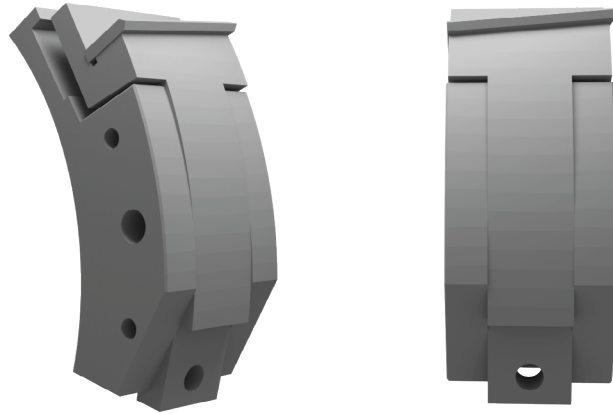

**LAP CUTTING KNIVES AND ANVIL**

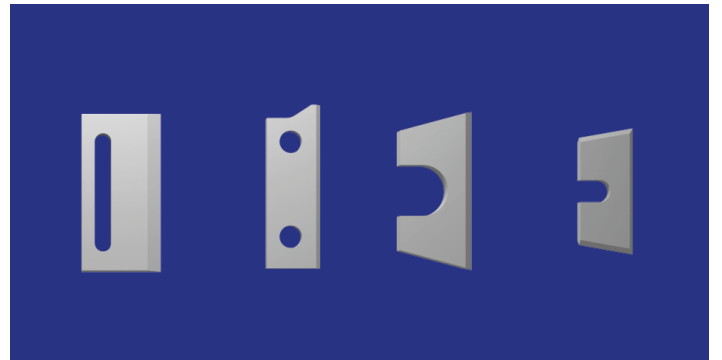
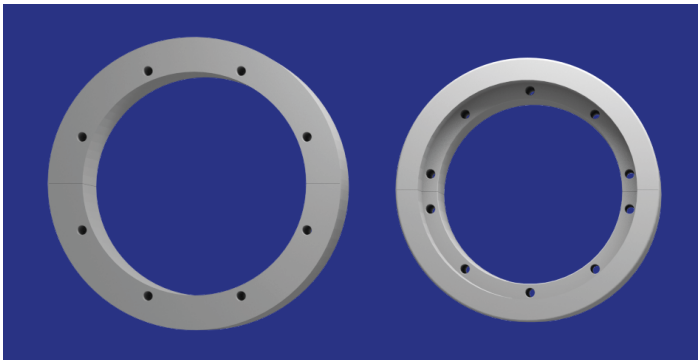

**BOXMAKER**

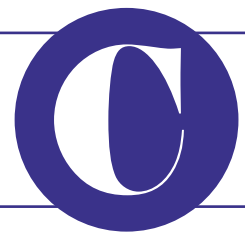

**BLADE**

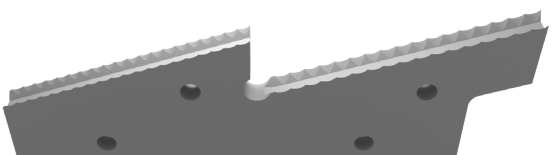

# CORRUGATED BOARD

